



landscape • entertainment • architectural • hospitality • illumination

DL-04 DIRECTIONAL LIGHTS





DIRECTIONAL LIGHTS DL-04 SERIES



TYPE

SPECIFICATIONS

CONSTRUCTION: Extruded aluminum; stamped brass, copper or stainless steel; matching cast aluminum or brass adjustable swivel (copper has cast brass swivel)

REFLECTOR: Diamond embossed specular aluminum

LENS: Brass/Copper/SS - clear tempered glass; Aluminum - high impact clear acrylic

LAMP SUPPLIED: 18w S8 #1141; 1200 hours average rating (25w max.)
Note: 35w max with DC socket

LAMP OPTIONS: We recommend 3w 50,000 hours average rating OMNI-3 LED (-LED3) or OMNI-3 Super Saver (-LED3S) 10,000 hours average rating 20w Xenon (-X) or 20w Halogen (-H)

SOCKET: Single contact bayonet, brass nickel plated lamp socket screw shell (Ba15s); double contact bayonet base (Ba15d) for 120v., both with 200°C silicone lead wires

WIRING: Black 3 foot 18/2 zip cord from base of fixture (12v. only)

For 25 foot 16/2 fixture lead wire add -25F to catalog number.
120v standard wiring

CONNECTION: FA-05 Quick Connector (not supplied) from fixture to main cable (12/2, 10/2 or 8/2 only) 12v. only

MOUNTING: FA-03 black 9" ABS stake threaded 1/2" NPS

FINISH: Aluminum-Black texture polyester powder coat. Optional finishes available
Brass-Unfinished brass. Optional finishes available

ORDERING INFORMATION

CATALOG NO.	DESCRIPTION	LAMP	EST. SHIP WEIGHT
DL-04-BLT	Aluminum Floodlight	18w S8 #1141	2.0 lbs.
DL-04-BRS	Brass Floodlight	18w S8 #1141	3.0 lbs.
DL-04-COP	Copper Floodlight	18w S8 #1141	2.0 lbs.
DL-04-SS	316 Stainless Steel Floodlight	18w S8 #1141	2.0 lbs.



DL-04-X-SS

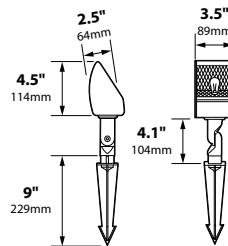

MOUNTING ACCESSORIES

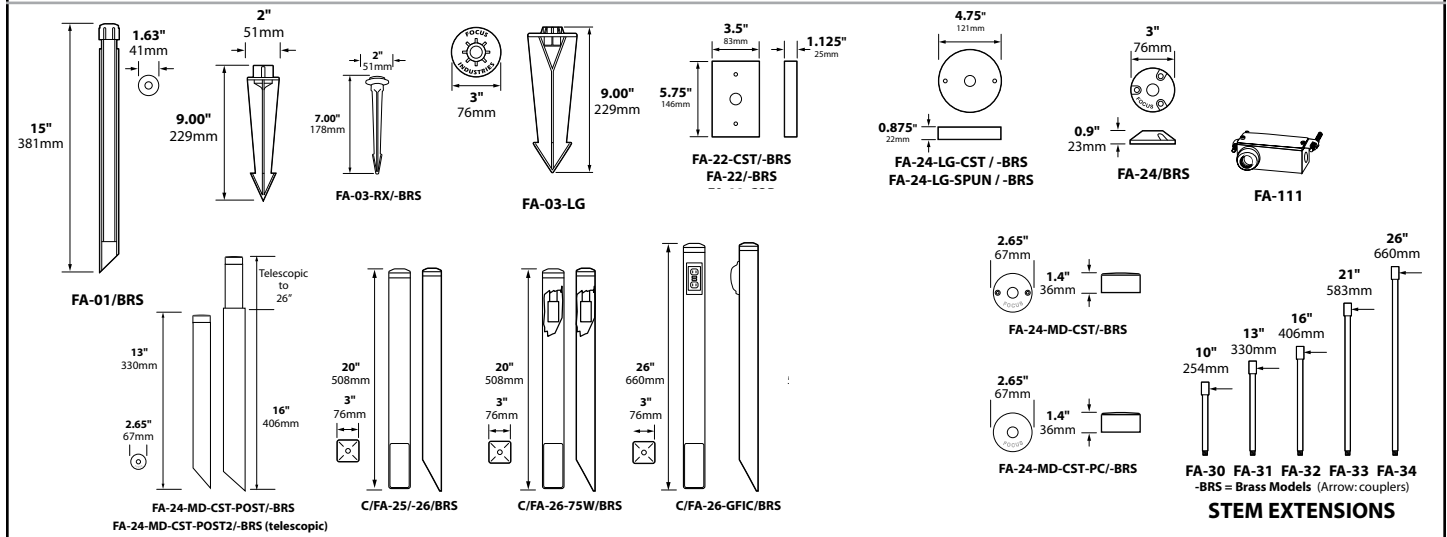

BEAM/GLARE CONTROL ACCESSORIES

FA-07 Square 1/4" Hex Cell Louver

FA-10-BLUE Blue Plastic Gel

FA-10-GREEN Green Plastic Gel

-HE Add to catalog # for Hood Extension (Aluminum only)

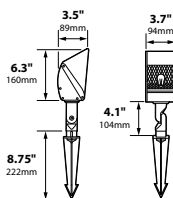

DL-04-HE
With Hood Extension
(Aluminum only)

JOB INFORMATION

Type: _____ Date: _____

Job Name: _____

Cat. No.: _____

Lamp(s): _____

Specifier: _____

Contractor: _____

Notes: _____

FOCUS INDUSTRIES INC.
25301 COMMERCENTRE DRIVE
LAKE FOREST, CA 92630

www.focusindustries.com
sales@focusindustries.com
(949) 830-1350 • FAX (949) 830-3390

Black Texture (Standard)	Antique Verde	Bronze Texture	Camel	White Texture	Hunter Texture	Rust	Weathered Iron	Weathered Brown	Stucco	Rubbed Verde	Chrome Powder	Acid Rust	Acid Verde	Black Acid Treatment
-BLT	-ATV	-BRT	-CAM	-WTX	-HTX	-RST	-WIR	-WBR	-STU	-RBV	-CPR	-BAR/CAR	-BAV/CAV	-BAT



DIRECTIONAL LIGHTS DL-04 SERIES



TYPE

LIGHT DISTRIBUTIONS AND PHOTOMETRICS

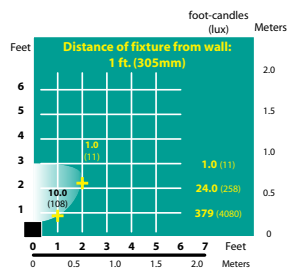

DL-04-HE
Half Spread Photometrics

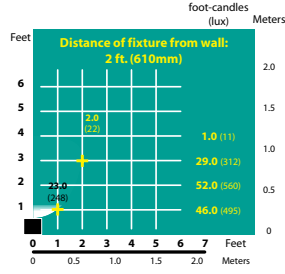

DL-04-HE
Half Spread Photometrics

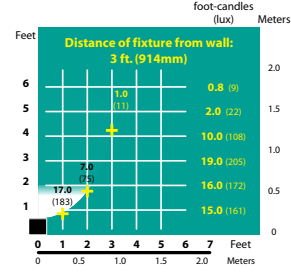

DL-04-HE
Half Spread Photometrics

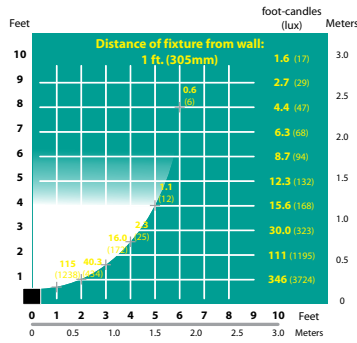

DL-04
Half Spread Photometrics

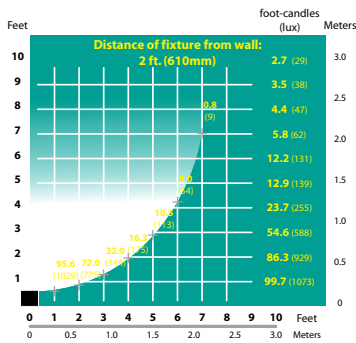

DL-04
Half Spread Photometrics

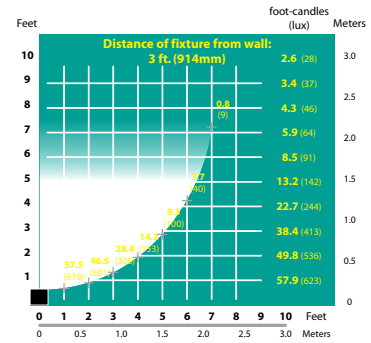

DL-04
Half Spread Photometric

Black Texture (Standard)	Antique Verde	Bronze Texture	Camel	White Texture	Hunter Texture	Rust	Weathered Iron	Weathered Brown	Stucco	Rubbed Verde	Chrome Powder	Acid Rust	Acid Verde	Black Acid Treatment
-BLT	-ATV	-BRT	-CAM	-WTX	-HTX	-RST	-WIR	-WBR	-STU	-RBV	-CPR	-BAR/CAR	-BAV/CAV	-BAT