



PROFESSIONAL
OUTDOOR LIGHTING

SPECIFICATION SHEET

Type:

Model:

Project:

TRM Tree Ring Mount • Architectural Series • TRM-4 • Accessories

DESCRIPTION:

The Tree Ring Mount is available with an automatic or manual adjustment feature for sustainable tree growth, suitable for the mounting of three accent lights. The Tree Ring Mount accommodates tree ring diameters from 8" to 22". TRM-4 (4 box) model has 4" of total diameter adjustment. The Automatic Adjustment feature allows for 2" of tree diameter growth without the need to manually adjust. The TRM-4 Automatic Adjustment Model is available in 24" diameters (8"-12" tree diameter), 27" diameters (10"-14" tree diameter), or 30" diameters (13"-17" tree diameters). The TRM-4 Manual Model is available in 24" diameters (13"-15" tree diameter), 27" diameters (16"-18" tree diameter), or 30" diameters (19"-21" tree diameters). Tree Ring Mount is suitable for wet locations.

FINISH:

18 powder-coated color options, including Black, Architectural Bronze, Light Bronze, Dark Bronze, Special Bronze, Verde, Pewter, Architectural Brick, Granite, Graphite Metallic, Rust, Hunter Green, Mocha, Weathered Bronze, Weathered Iron, White and Glossy Gray.

ACCESSORY SPECIFICATIONS

JUNCTION BOX:

Die cast, low copper content, A360 aluminum offers maximum corrosion protection. Stainless steel fasteners affixed to a minimalistic styled flat door (standard). Door is stamped 5052-H32 aluminum. Fully gasketed using die cut silicon sheet affixed to door.

ELECTRICAL SUPPLY OPENINGS:

One NPT 1/2"-14 bottom hub opening available for connection of flexible, outdoor rated conduit.

STRAP:

Heavy duty aluminum strap, 1/8" thick x 3" wide affixed to each Junction Box with stainless steel fasteners. Strap is hinged and held with two 1/2" diameter stainless steel bolts. Hinge bolts are retained with stainless steel /nylon locking hex nuts. Hinged strap allows for easy installation around trees.

ADJUSTMENT TREE CLAMPING:

Tree clamp features a manual adjustment that can adjust up to 2" per side to accommodate tree growth. This adjustment feature uses 3/8" stainless steel threaded rod with a 1-1/2" diameter machined clamp foot to affix to the tree. The clamp foot is designed to securely affix the Tree Ring Mount to the tree with minimum damage to the bark.

WIRING:

Each junction box electrically connected using ST00W 18/3 or 18/5 (dimming) outdoor rated cable. Cable sealed to each junction box with polymeric watertight cord seals.

TRM-4 LOAD RATING:

Maximum load of **5.5 pounds** per junction box. Tested to UL 1598/CSA C22 No. 250.0 Standard.

UL & CUL Wet Loading Listing.

All Vista Architectural luminaires are [MADE IN THE U.S.A.](#)

DIMENSIONS:

TRM-4 AUTOMATIC ADJUSTMENT

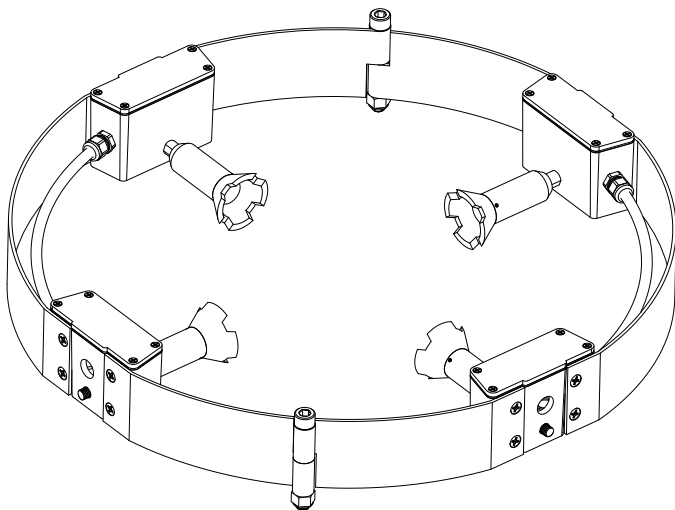

TRM-4 MANUAL ADJUSTMENT

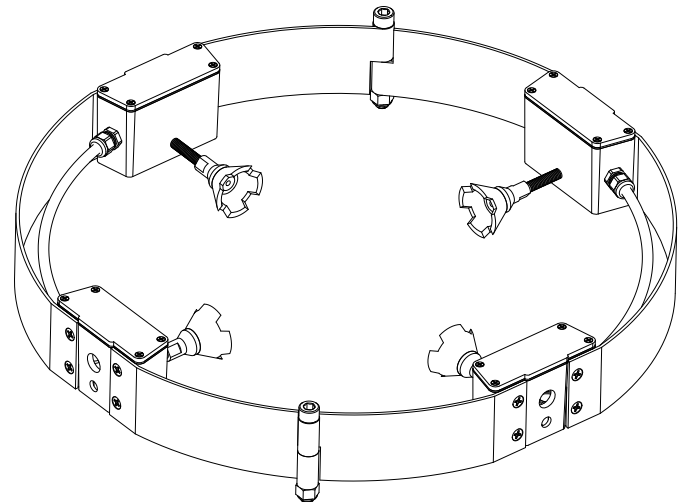

Vista Professional Outdoor Lighting reserves the right to modify the design and/or construction of the fixture shown without further notification.



SPECIFICATION SHEET

4 BOX AUTOMATIC DIMENSIONS:

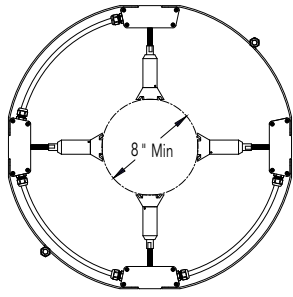

24"

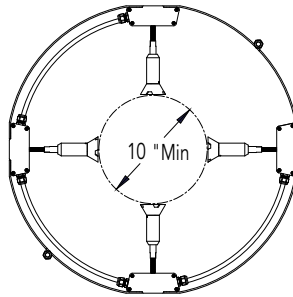

27"

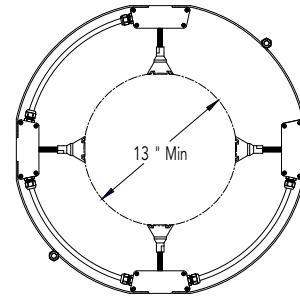

30"

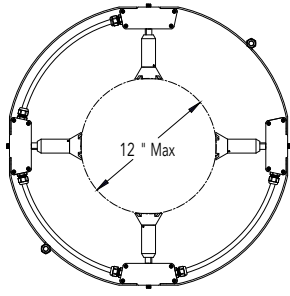

24"

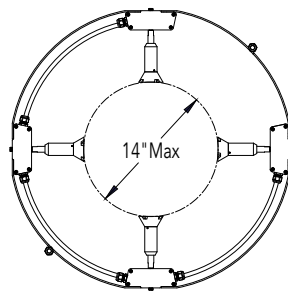

27"

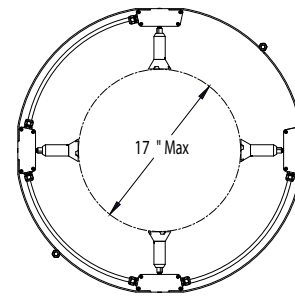

30"

4 BOX MANUAL DIMENSIONS:

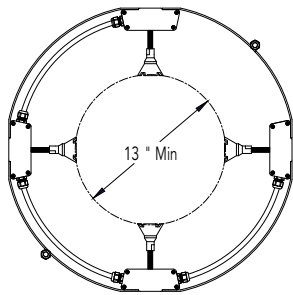

24"

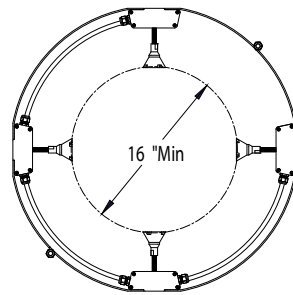

27"

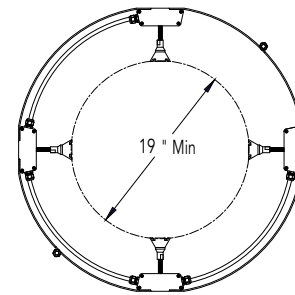

30"

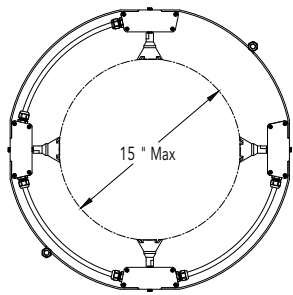

24"

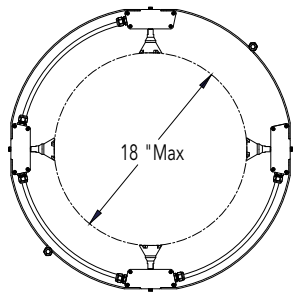

27"

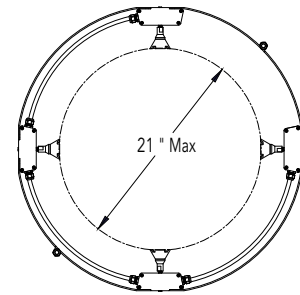

30"

Vista Professional Outdoor Lighting reserves the right to modify the design and/or construction of the fixture shown without further notification.



SPECIFICATION SHEET

TRM Tree Ring Mount • Architectural Series • TRM-4 • Accessories

ACCESSORY ORDERING INFORMATION

TO ORDER ACCESSORY: Select appropriate choice from each column as in the following example.

EXAMPLE: TRM-4-Z-AE-24-B12-ND

MODEL	JUNCTION BOX QTY	FINISH	ADJUSTMENT METHOD	TREE RING DIAMETER	ELECTRICAL HUB ENTRY	INPUT/DIMMING
TRM	4 - Four boxes 90° apart	Standard	AE - Automatic Expansion	AUTOMATIC 24 - 24" (Tree Diameter Range: 8" - 12") 27 - 27" (Tree Diameter Range: 10" - 14") 30 - 30" (Tree Diameter Range: 13" - 17")	B12 - NPT 1/2" - 14 bottom*	LV - 2 Conductor Cabling (Low Voltage) ND - 3 Conductor Cabling-ND & PCT (Line Voltage) 010 - 5 Conductor Cabling (Line Voltage)
		B - Black Z - Architectural Bronze DZ - Dark Bronze GT - Granite W - White				
		Premium				
		BR - Architectural Brick LZ - Light Bronze SB - Special Bronze GG - Glossy Gray R - Rust HG - Hunter Green WB - Weathered Bronze WI - Weathered Iron GM - Graphite Metallic	MA - Manual Adjustment	MANUAL 24 - 24" (Tree Diameter Range: 13" - 15") 27 - 27" (Tree Diameter Range: 16" - 18") 30 - 30" (Tree Diameter Range: 19" - 21")		
		Hand Finished				
		G - Verde P - Pewter M - Mocha OF - Olde Finish				
NOTE: Mounting of three accent lights is available. See the TRM-3 Specification Sheet.						

*Only one box will have a bottom hub entry.