



**PROFESSIONAL
OUTDOOR LIGHTING**

Type: _____
 Model: _____
 Project: _____

SPECIFICATION SHEET

MODEL 1205 Architectural Series • Path & Spread Lights

FIXTURE SPECIFICATIONS:

LAMP TYPE:

A19- Incandescent. 75W Maximum.

Lamp not included with fixture, order separately.

HOUSING:

Die-cast, copper-free aluminum.

STEM:

1/2" schedule-40 aluminum pipe with 1/2" NPT. Standard 12" stem is included with fixtures – optional and custom stems available.

FINISH:

Polyester powder-coat finish available in Black, Verde, Architectural Brick, Architectural Bronze, Light Bronze, Dark Bronze, Granite, Pewter, Terracotta, Rust, Hunter Green, Mocha, Weathered Bronze, Weathered Iron, and White.

SOCKET/LAMP HOLDER:

Top grade porcelain, medium base 4KV pulse rated socket with spring center contact and a silicone rubber jacket protector to prevent moisture/debris from entering socket.

LENS:

Clear or frosted, gasketed, threaded, tempered glass vapor globe.

MOUNTING:

Aluminum stem with 1/2" NPT on bottom and jam nut included. Fixture may be mounted into threaded hubs in junction boxes, ground stakes, or grade-mounted ballast enclosures.

FASTENERS:

All fasteners are stainless steel.

WIRING:

Prewired with 200°C-rated wire along with a grounded lead.

CERTIFICATION:

UL Listed to U.S. and Canadian safety standards for line voltage landscape luminaires (UL 1598). The maximum wattages allowed by Underwriters Laboratories (UL) for the U.S. and Canadian markets may vary. Maximum wattages specified are Underwriters Laboratories U.S. standard. Please contact Vista for any questions about the maximum wattages allowed by UL Canadian standards.

All Vista luminaires are **MADE IN THE U.S.A.**

DIMENSIONS:

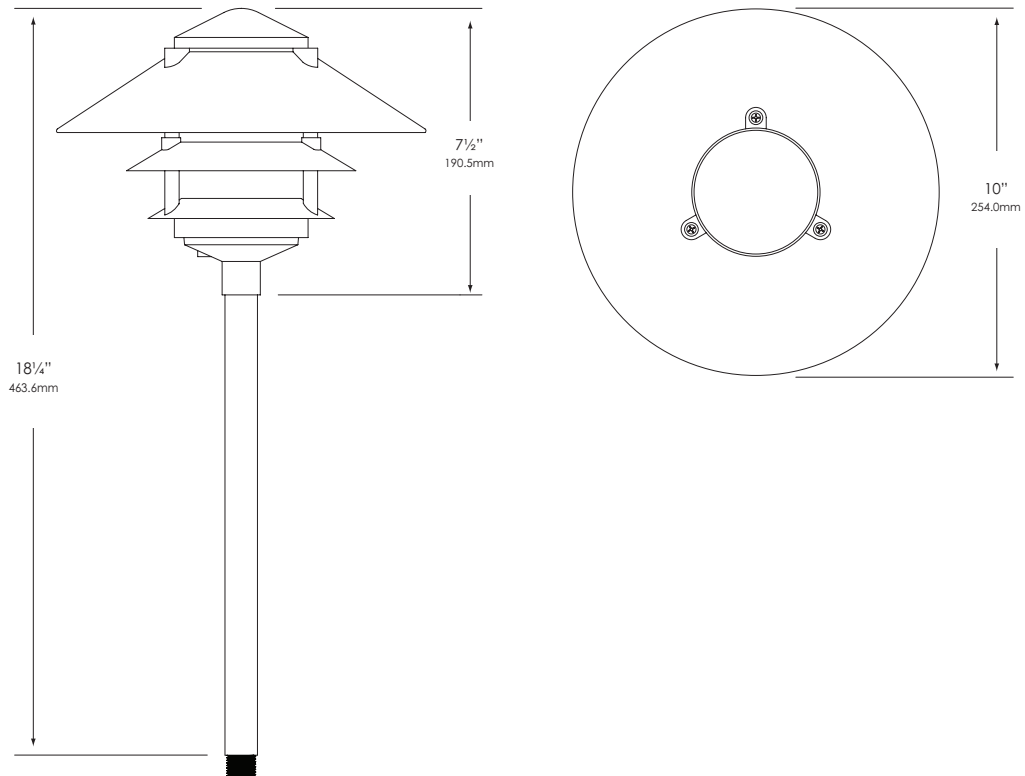

Vista Professional Outdoor Lighting reserves the right to modify the design and/or construction of the fixture shown without further notification.



SPECIFICATION SHEET

MODEL 1205 Architectural Series • Path & Spread Lights

FIXTURE ORDERING INFORMATION

TO ORDER FIXTURE: Select appropriate choice from each column as in the following example.

EXAMPLE: 1205-B-CR

MODEL	FINISH	LENS
1205	B - Black G - Verde BR - Architectural Brick Z - Architectural Bronze LZ - Light Bronze DZ - Dark Bronze GT - Granite P - Pewter TC - Terracotta R - Rust HG - Hunter Green M - Mocha WB - Weathered Bronze WI - Weathered Iron W - White	CR – Clear lens FR – Frosted lens

Lamp not included with fixture, order separately. For available lamps, see Lamp Guide, Vista catalog.